

Ignition transformers TZI, TGI

OPERATING INSTRUCTIONS

Cert. Version 12.22 · Edition 12.23 · EN · 03251630



1 SAFETY

1.1 Please read and keep in a safe place



Please read through these instructions carefully before installing or operating. Following the installation, pass the instructions on to the operator. This unit must be installed and commissioned in accordance with the regulations and standards in force. These instructions can also be found at www.docuthek.com.

1.2 Explanation of symbols

1, 2, 3, a, b, c = Action

→ = Instruction

1.3 Liability

We will not be held liable for damage resulting from non-observance of the instructions and non-compliant use.

1.4 Safety instructions

Information that is relevant for safety is indicated in the instructions as follows:

⚠ DANGER

Indicates potentially fatal situations.

⚠ WARNING

Indicates possible danger to life and limb.

⚠ CAUTION

Indicates possible material damage.

All interventions may only be carried out by qualified gas technicians. Electrical interventions may only be carried out by qualified electricians.

1.5 Conversion, spare parts

All technical changes are prohibited. Only use OEM spare parts.

CONTENTS

1 Safety	1
2 Checking the usage	2
3 Installation	3
4 Wiring	3
5 Commissioning	5
6 Electromagnetic compatibility (EMC)	5
7 Assistance in the event of malfunction	5
8 Technical data	6
9 Logistics	7
10 Accessories	8
11 Certification	8
12 Disposal	8

2 CHECKING THE USAGE

TZI, TGI

For the high-voltage ignition of gas burners and gas-ignited or directly ignited oil burners with a one-pole output to the protective earth. The ignition transformers can also be used on burners with single-electrode operation. A burner control unit with an integral fuse must be used for activation. This function is only guaranteed when used within the specified limits – see page 6 (8 Technical data). Any other use is considered as non-compliant.

TZI

The ignition transformer TZI must be mounted in a non-contact housing, for example in a control cabinet. TZI fulfils the requirements for enclosure IP 00.

TGI

Ignition transformer TGI in its die-cast aluminium housing meets the requirements for enclosure IP 65, NEMA 4. The TGI is suitable for on-site mounting near the burner.

2.1 Type code

TZI	Ignition transformer
TGI	Ignition transformer, enclosed
5	5 kV high voltage
8	8 kV high voltage
-12	Output current: 12 mA at 50 Hz (9 mA at 60 Hz)
-15	Output current: 15 mA at 50 Hz (10–11 mA at 60 Hz)
-20	Output current: 20 mA at 50 Hz (16 mA at 60 Hz)
/19	19% duty cycle
/33	33% duty cycle
/100	100% duty cycle
Q	Mains voltage: 120 V AC
W	Mains voltage: 230 V AC
E	CE approved
T	UL listed, CSA approved

2.2 Part designations

2.2.1 TZI

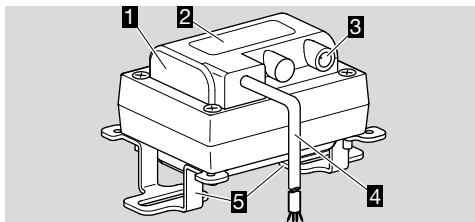

- 1 Ignition transformer
- 2 Type label
- 3 Ignition cable connection
- 4 Mains cable
- 5 Attachment bracket

2.2.2 TGI

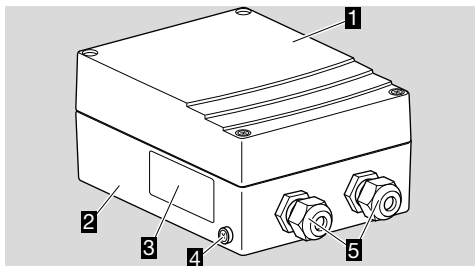

- 1 Upper housing section
- 2 Lower housing section
- 3 Type label
- 4 PE connection
- 5 M20 cable gland

2.3 Type label

Mains voltage, ignition voltage, duty cycle, current consumption, output current and enclosure – see type label

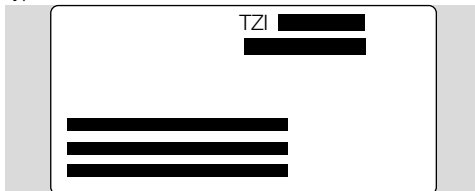

3 INSTALLATION

⚠ CAUTION

Incorrect installation!

Please observe the following to ensure that the unit is not damaged during installation and operation:

- Dropping the device can cause permanent damage. In this event, replace the entire device and associated modules before use.
- **TZI**: install in external housing or control cabinet with enclosure \geq IP 54. Ensure that a warning sign with the wording "Warning: electricity" to DIN EN ISO 7010 in permanently legible condition is placed on the external housing or control cabinet.
- **TZI, TGI**: ground the housing.
- Installation position: vertical, with connections at the bottom or horizontal (TZI: standing on attachment brackets, TGI: lying flat), with connections to the side.

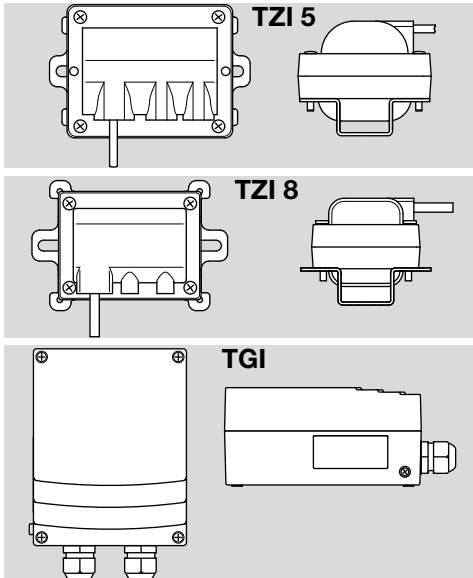

- Position the ignition transformer right next to the burner (ignition cable length: max. 5 m, recommended < 1 m).

4 WIRING

- Cable for burner ground/PE wire: 4 mm².
- **TGI**: mains power cable: max. 1.5 mm².
- For the ionization and ignition cables, use un-screened high-voltage cable:
FZLSi 1/7 -50 to +180°C (-58 to +350°F), Order No. 04250410,
or
FZLK 1/7 -5 to +80°C (23 to 176°F), Order No. 04250409.

⚠ DANGER

Electric shocks can be fatal!

- Check the insulation of the high-voltage cable for damage and replace if required.
- Avoid electrical interference on the ionization cable.
- Do not lay UV/ionization cable and ignition cable together and lay them as far apart as possible.
- Length of ignition cable: < 1 m (3.28 ft), max. 5 m (16.4 ft).
- Lay cables individually and, if possible, not in a metal conduit.
- Only use radio interference suppressed terminal boots with 1 k Ω resistor, see page 8 (10 Accessories).
- 1** Disconnect the system from the electrical power supply.
- 2** Screw the ignition cable securely into the high-voltage connection **H** and run to the burner by the shortest possible route.

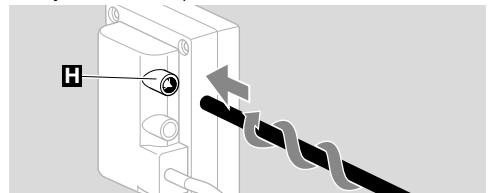

- 3** Wire the ignition transformer as shown in the connection diagram.

4.1 Connection diagram

Legend

H	High-voltage connection	
	PE wire connection	
	Burner ground connection	
	Flame control	
	Burner control unit	
	TZI/TGI..E	TZI/TGI..T
	L = black core	L = black core
	N = blue core	N = white core
	Brown core	Red core
	PE = green/ yellow core	PE = green core

Double-electrode operation

TZI

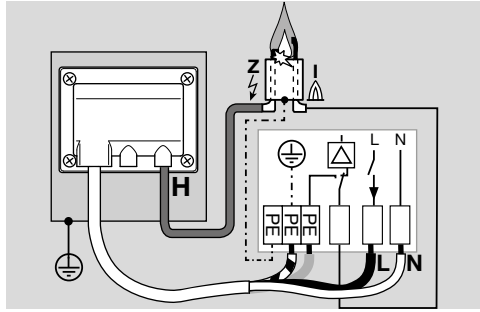

TGI

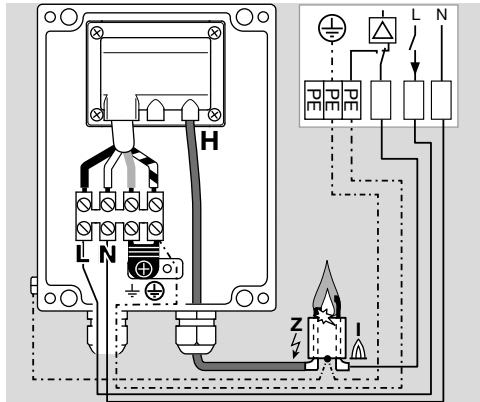

Single-electrode operation

- Single-electrode operation is possible only in conjunction with suitable burner control units.
- For single-electrode operation, wire an equipotential bond between the burner and the burner control unit.

TZI

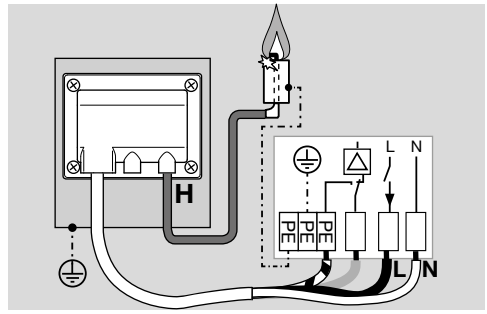

TGI

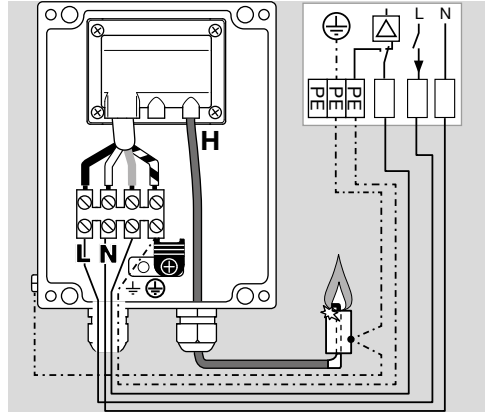

5 COMMISSIONING

⚠ WARNING

Danger of death!

High voltage is supplied to the high-voltage connection on the TZI, TGI during the ignition process.

- A burner control unit with an integral fuse to suit the current consumption of the ignition transformer must be installed for activation.
- Do not operate the TZI or TGI unless ignition sparks are formed.
- 1** Check the distance between spark electrode and burner ground (2 ± 0.5 mm) before commissioning the TZI, TGI.

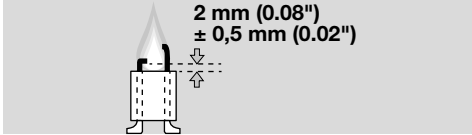

- Do not exceed the specified duty cycle and ambient temperature, see also page 6 (8 Technical data). Refer to Technical Information TZI, TGI for converting the duty cycle into seconds.

6 ELECTROMAGNETIC COMPATIBILITY (EMC)

⚠ CAUTION

Radio interference!

Please observe the following to ensure that no damage occurs during installation and operation:

- The high-voltage arc may cause radio interference. For this reason, burners and systems with fitted TZI or TGI are subject to the EMC Directive. The system manufacturer must ensure compliance with the EMC limits set out in EN IEC 61000-6-4, for example.

7 ASSISTANCE IN THE EVENT OF MALFUNCTION

⚠ WARNING

Electric shocks can be fatal!

- Before working on possible live components, ensure the unit is disconnected from the power supply.
- Fault-clearance must only be undertaken by authorized trained personnel!
- Do not carry out repairs on the TZI, TGI on your own as this will cancel our guarantee. Unauthorized repairs or incorrect electrical connections can cause the burner control unit and the TZI or TGI to become defective. In this case, fail-safe operation can no longer be guaranteed.
 - Faults may be cleared only using the measures described below –
- If the TZI, TGI does not react despite the faults having been rectified –
 - Remove the unit and return it to the manufacturer for inspection.

Assistance in the event of malfunction

? Fault

! Cause

- **Remedy**

? No ignition spark?

- !** The ignition cable is too long.
 - Check the length of the ignition cable and shorten it if necessary. Length of ignition cable: < 1 m (3.28 ft), max. 5 m (16.4 ft).
- !** Power supply to the TZI, TGI is defective.
 - Check the power supply.
- !** The PE connection on the TZI, TGI is defective.
 - Check the PE connection (TZI/TGI..E = brown core, TZI/TGI..T = red core).
- !** The high-voltage cable has no contact with the terminal boot/ignition transformer.
 - Secure the high-voltage cable firmly to the terminal boot/high-voltage connection on the ignition transformer.
- !** Ignition cable/spark electrode has a short-circuit to PE.
 - Check installation, clean the spark electrode.
- ? Abnormal EMC fault?**
- !** A radio interference suppressed terminal boot has not been used.
 - Use a radio interference suppressed terminal boot, see page 8 (10 Accessories).

8 TECHNICAL DATA

Mains voltage:

TZI..Q, TGI..Q: 120 V AC, 50/60 Hz,

TZI..W, TGI..W: 230 V AC, 50/60 Hz.

Output voltage:

TZI 5, TGI 5: 5 kV,

TZI 8, TGI 8: 8 kV.

Electrode distance: 2 ± 0.5 mm.

Length of ignition cable: < 1 m (3.28 ft), max. 5 m (16.4 ft).

Enclosure:

TZI: IP 00,

TGI: IP 65, NEMA 4.

Ambient temperature: -20 to +60°C.

TZI, TGI: silicone-free.

Weight:

TZI../19: 1.4 kg,

TZI../33, TZI../100: 2.0 kg,

TGI../19: 2.5 kg,

TGI../33, TGI../100: 3.1 kg.

TZI

Type	Input		Output		Duty cycle ²⁾
	A ¹⁾		mA ¹⁾		%
TZI 5-15/100QE	0.9	(0.6)	15	(11)	100
TZI 5-15/100QT	0.9	(0.6)	15	(11)	100
TZI 5-15/100WE	0.4	(0.3)	15	(10)	100
TZI 8-20/19QE	1.9	(1.4)	20	(16)	19
TZI 8-20/19QT	1.9	(1.4)	20	(16)	19
TZI 8-20/19WE	1.0	(0.7)	20	(16)	19
TZI 8-12/100QE	1.2	(0.9)	12	(9)	100
TZI 8-12/100QT	1.2	(0.9)	12	(9)	100
TZI 8-12/100WE	0.6	(0.4)	12	(9)	100
TZI 8-20/33QE	1.7	(1.3)	20	(16)	33
TZI 8-20/33QT	1.7	(1.3)	20	(16)	33
TZI 8-20/33WE	1.0	(0.7)	20	(16)	33

Duty cycle [%]:

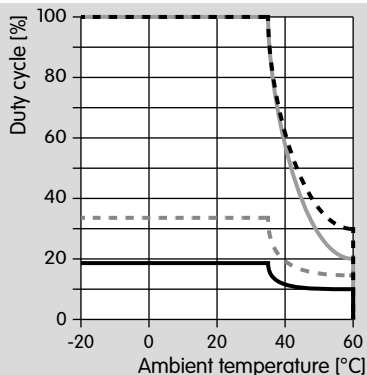

TZI 5-15/100 = - - - - -

TZI 8-12/100 = _____

TZI 8-20/19 = _____

TZI 8-20/33 = - - - - -

TGI

Type ³⁾	Input		Output		Duty cycle ²⁾
	A ¹⁾		mA ¹⁾		%
TGI 5-15/100QE	0.9	(0.6)	15	(11)	100
TGI 5-15/100QT	0.9	(0.6)	15	(11)	100
TGI 5-15/100WE	0.4	(0.3)	15	(10)	100
TGI 8-20/19QE	1.9	(1.4)	20	(16)	19
TGI 8-20/19QT	1.9	(1.4)	20	(16)	19
TGI 8-20/19WE	1.0	(0.7)	20	(16)	19
TGI 8-12/100QE	1.2	(0.9)	12	(9)	100
TGI 8-12/100QT	1.2	(0.9)	12	(9)	100
TGI 8-12/100WE	0.6	(0.4)	12	(9)	100
TGI 8-20/33QE	1.7	(1.3)	20	(16)	33
TGI 8-20/33QT	1.7	(1.3)	20	(16)	33
TGI 8-20/33WE	1.0	(0.7)	20	(16)	33

¹⁾ Values in brackets apply to 60 Hz.

²⁾ Within 3 minutes at -20 to +35°C.

³⁾ Cores of the connection cable: TZI/TGI..E = black, blue, brown, green-yellow; TZI/TGI..T = black, white, red, green.

9 LOGISTICS

Transport

Protect the unit from external forces (blows, shocks, vibration).

Transport temperature: see page 6 (8 Technical data).

Transport is subject to the ambient conditions described.

Report any transport damage on the unit or packaging without delay.

Check that the delivery is complete.

Storage

Storage temperature: see page 6 (8 Technical data).

Storage is subject to the ambient conditions described.

Storage time: 6 months in the original packaging before using for the first time. If stored for longer than this, the overall service life will be reduced by the corresponding amount of extra storage time.

10 ACCESSORIES

10.1 Radio interference suppressed terminal boots

Right-angle terminal boot, 4 mm (0.16 inch), interference-suppressed,
Order No. 04115308.

Straight terminal boot, 6 mm (0.2 inch), interference-suppressed,
Order No. 04115306.

10.2 High-voltage cable

FZLSi 1/7 -50°C (-58°F) to +180°C (+356°F),
Order No. 04250410,

FZLK 1/7 -5°C (23°F) to +80°C (+176°F),
Order No. 04250409.

11 CERTIFICATION

11.1 Declaration of conformity



We, the manufacturer, hereby declare that the products TZI 5..E, TZI 8..E, TGI 5..E and TGI 8..E comply with the requirements of the listed Directives and Standards.

Directives:

- 2014/35/EU – LVD
- 2014/30/EU – EMC
- 2011/65/EU – RoHS II
- 2015/863/EU – RoHS III

Standards:

- EN 61558-2-3:2011-04
- Conformity with EN 61000-6-2:2005/AC:2005 and EN 61000-6-4:2007/A1:2011 must be checked by the system operator in the specific application in which the transformers are to be used.

The production is subject to the surveillance procedure pursuant to Regulation (EU) 2014/35 Annex III Module A.

Elster GmbH

Scan of the Declaration of conformity (D, GB) – see www.docuthek.com

FOR MORE INFORMATION

The Honeywell Thermal Solutions family of products includes Honeywell Combustion Safety, Eclipse, Exothermics, Hauck, Kromschroder and Maxon. To learn more about our products, visit ThermalSolutions.honeywell.com or contact your Honeywell Sales Engineer.

Elster GmbH
Strothweg 1, D-49504 Lotte
T +49 541 1214-0
hts.lotte@honeywell.com
www.kromschroeder.com

Global centralized service deployment coordination:
T +49 541 1214-365 or -555
hts.service.germany@honeywell.com

11.2 UL recognized

TZI..T only: USA and Canada.



For USA: Product Category XPZZ2, File No. E529373,

for Canada: Product Category XPZZ8, File No. E529373.

www.ul.com

11.3 Eurasian Customs Union



The products TZI, TGI meet the technical specifications of the Eurasian Customs Union.

12 DISPOSAL

Devices with electronic components:

WEEE Directive 2012/19/EU – Waste Electrical and Electronic Equipment Directive



At the end of the product life (number of operating cycles reached), dispose of the packaging and product in a corresponding recycling centre. Do not dispose of the unit with the usual domestic refuse. Do not burn the product.

On request, old units may be returned carriage paid to the manufacturer in accordance with the relevant waste legislation requirements.

Honeywell
kromschroder

Translation from the German
© 2023 Elster GmbH